

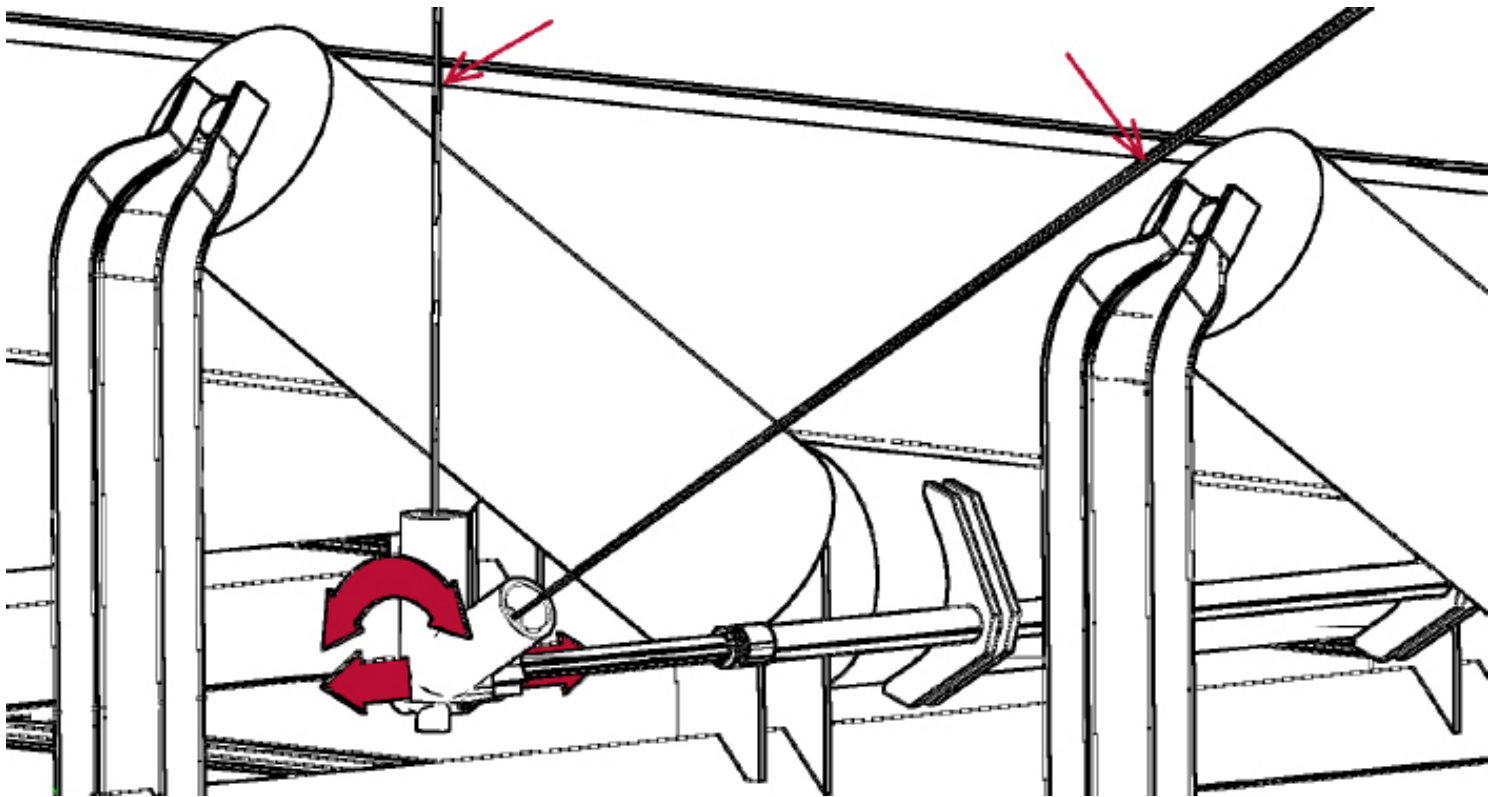

Alignment Verification Rig

For Precisely Squaring your Belt
Conveyor Idlers to the Belt



Align Laser to belt edge at 2 points to check if Idler is aligned

- Improve energy efficiency
- Reduce belt and roller wear
- Improve belt tracking stability
- Low cost and easy to use

Idler angular misalignment is one of the four main sources of conveyor operating friction. (see Chapter 6 of CEMA's Belt Book)

Align Once, Profit Forever

Basic Usage

Installed from one side of the conveyor, the AVR grabs the center roll with self-centering V blocks. Rotating the laser on its pivot shaft sweeps a plane perpendicular to the idler roll. A quick adjusting stop allows spotting the laser crosshair at 12 o'clock and fixing it at the belt edge. Simply sweep the laser to compare its location to points on the belt edge away from the idler to verify alignment. Idler angular adjustment can be made by loosening the mounting bolts and sliding in its slots until the crosshairs are centered on multiple locations along the belt edge before moving the AVR to the next idler.

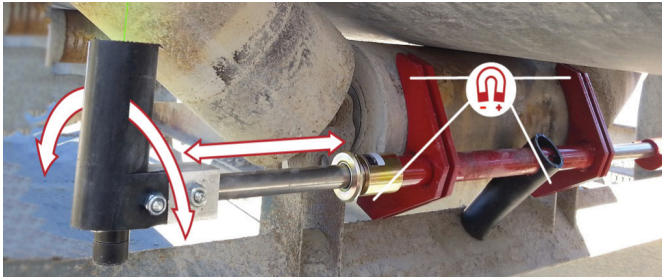

Typical Steps

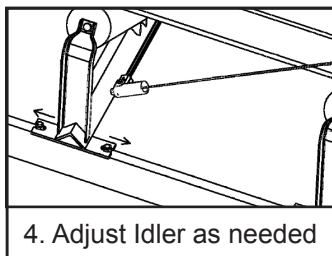
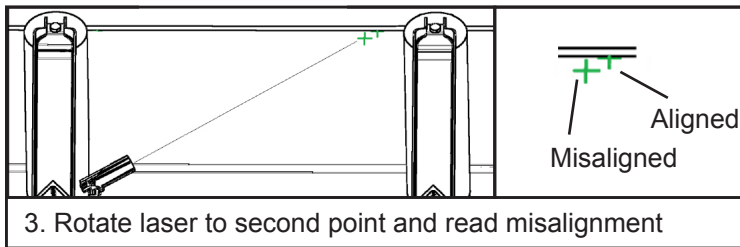
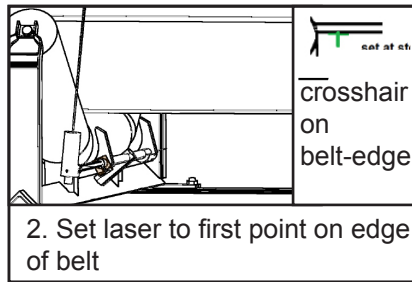
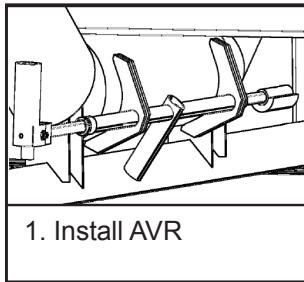

4. Adjust Idler as needed

This page is only for understanding the use of the AVR- see Users manual for details and especially for safe operation.

Hanging Targets

Included with the AVR is a hanging target that attach to the edge of the belt, allowing for even more accurate alignment by checking the belt edge further away.

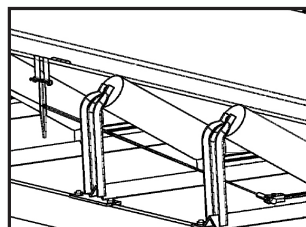

Why the AVR?

Idlers are equipped with slots allowing angular adjustment as needed for tracking but the optimum position perpendicular to the belt direction is uncertain.

Angular triangulation is tedious and requires two workers. More importantly, manufacturing variations in the idler frame and conveyor stringers mean conveyor and idler frames are not necessarily good for measuring points. The important components for precise angular location are the belt and the rolls, especially the center roll, but they are difficult to reference to each other.

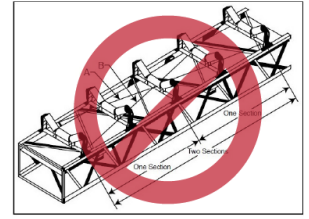

Ref. CEMA's 7th Ed. Belt Conveyors for Bulk Materials

AVR Features

- Magnetic V-blocks quickly and repeatedly clamp to align to the most important roller in the 3 roll troughing idler set- the center roll
- Durable welded steel construction.
- Works on troughing, single roll, and V return idlers.
- Crosshairs on laser allow for easy spotting
- Guarded, battery powered, green laser for high visibility and safe operation
- Ships in a reusable, protective storage and carrying case.

Return Roll Mounting

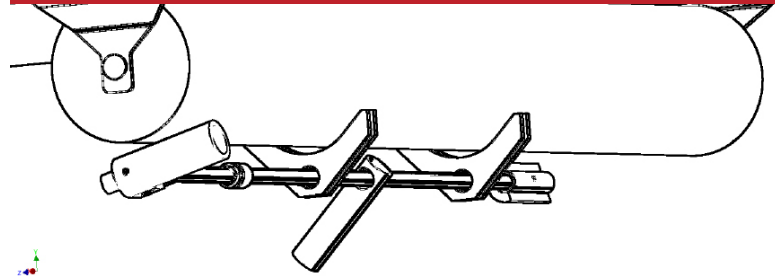

New Installations

The AVR can be used for aligning idlers before installing a belt. Simply use piano wire instead of the belt edge the belt edge, and align with or without hanging targets.

The AVR can also use the conveyor stringers if preferred.

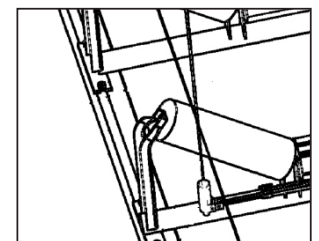

More information, an energy calculator and pricing available online at avr4idlers.com

Address questions to: averdsn@gmail.com / 641-651-0460